

CASING 3 1/2"

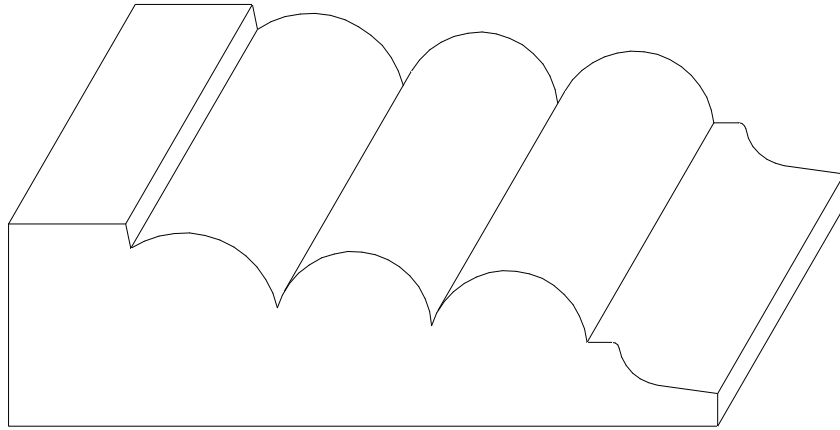

W-6
1" x 3 1/2"

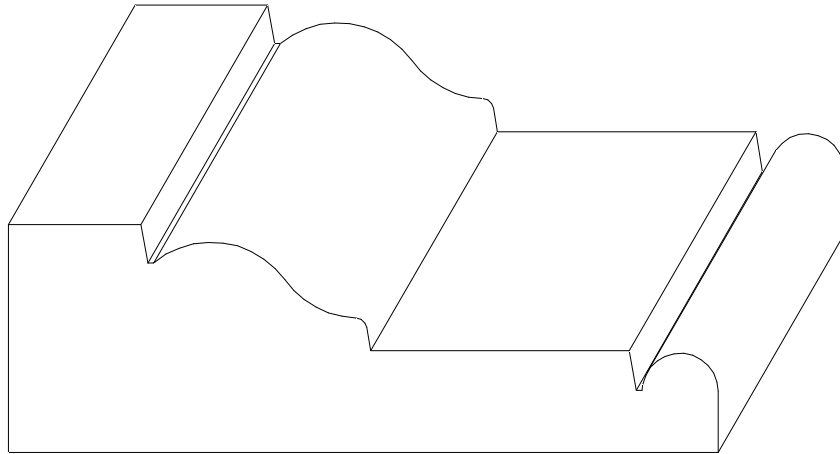

W-9
1 1/8" x 3 1/2"

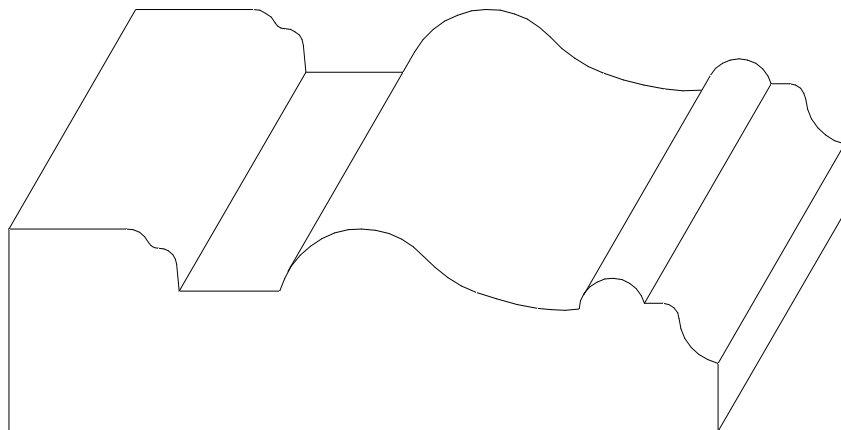

W-10
1" x 3 1/2"

CASING 3 1/2"

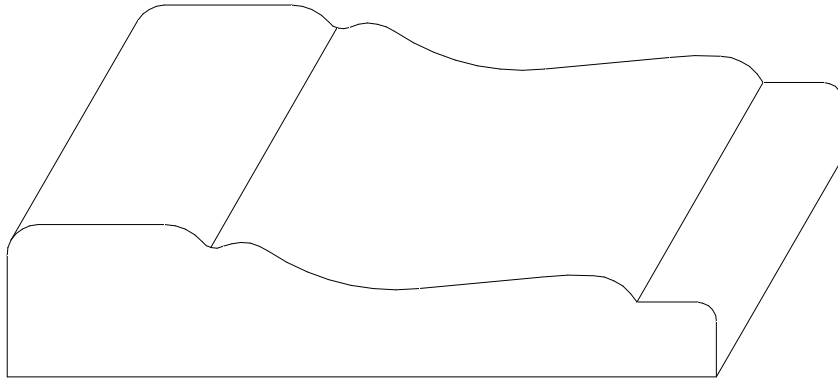

W-27
3/4" x 3 1/2"

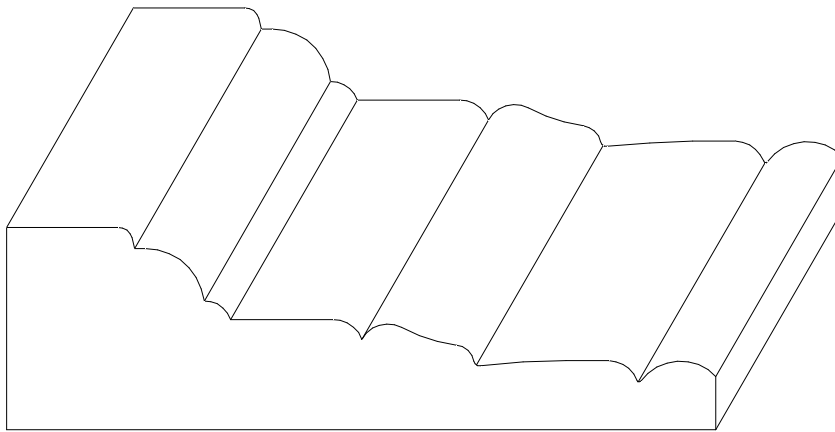

W-32
1" x 3 1/2"

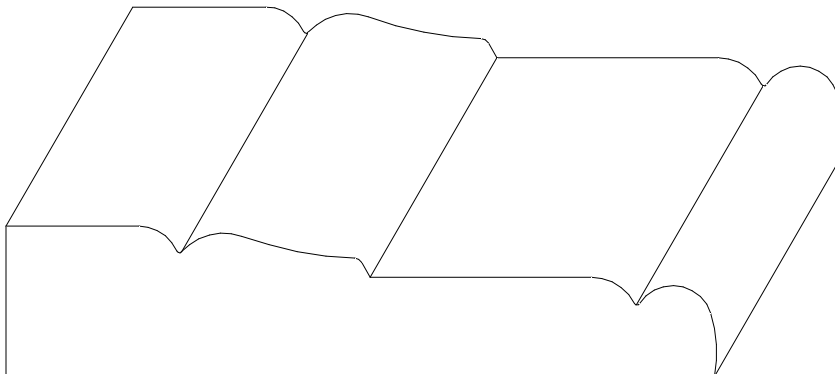

W-41
3/4" x 3 1/2"

CASING 3 1/2"

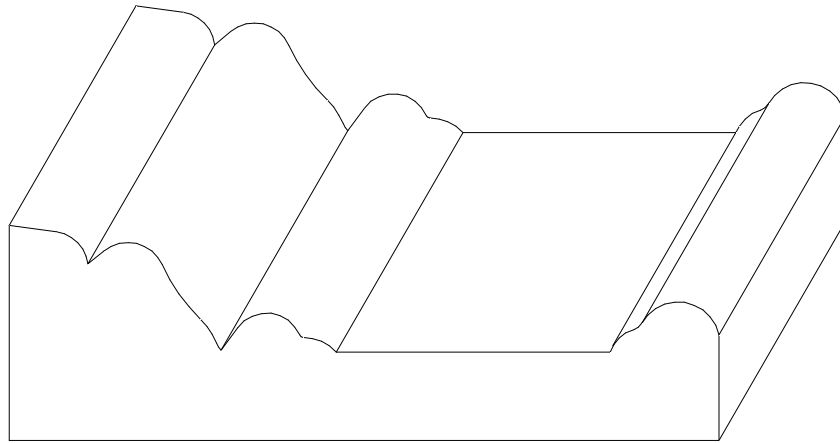

W-43
1 1/16" x 3 1/2"

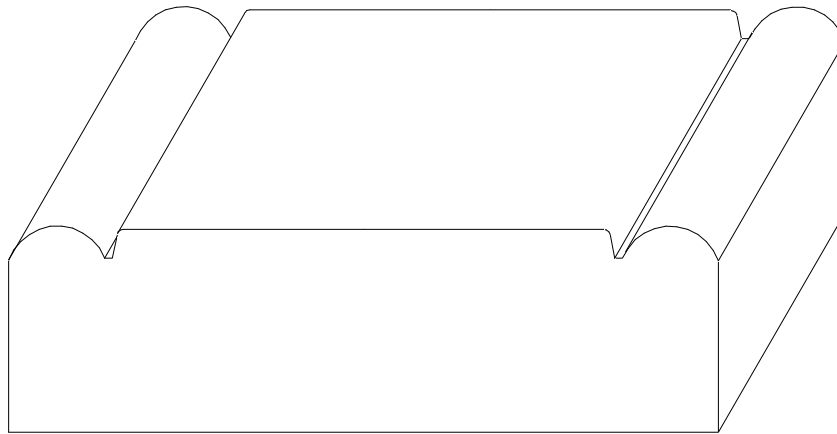

W-47
1" x 3 1/2"

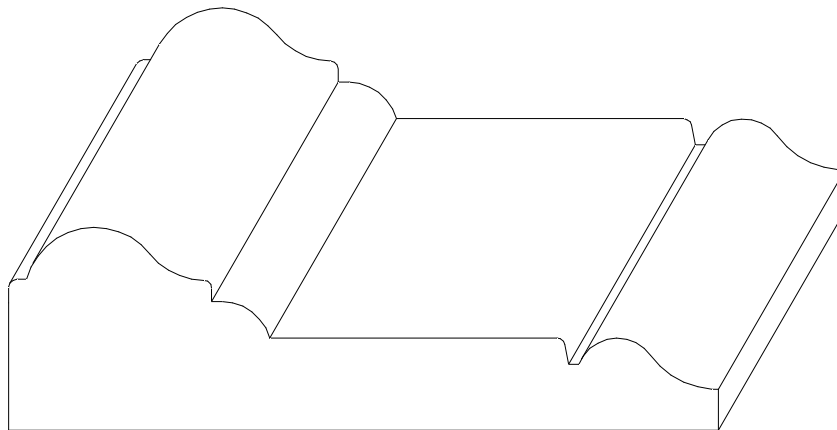

W-48
1" x 3 1/2"

CASING 3 1/2"

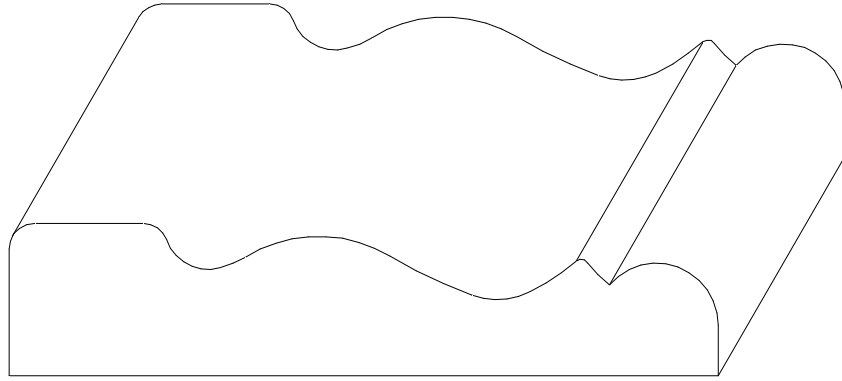

W-51
3/4" x 3 1/2"

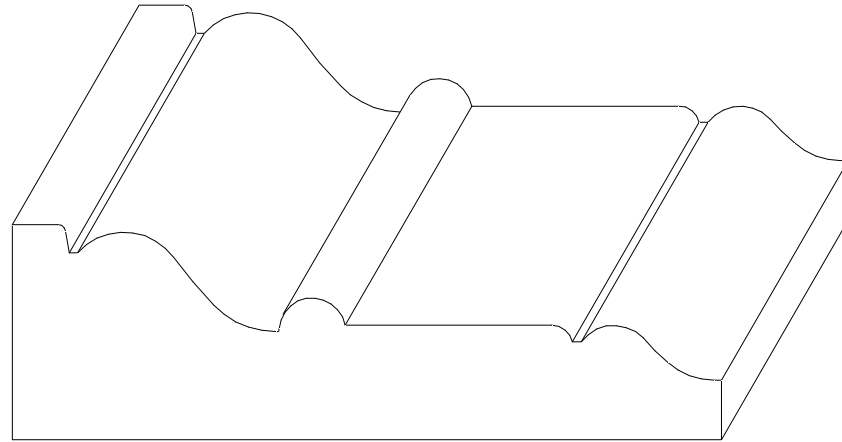

W-52
1 1/16" x 3 1/2"

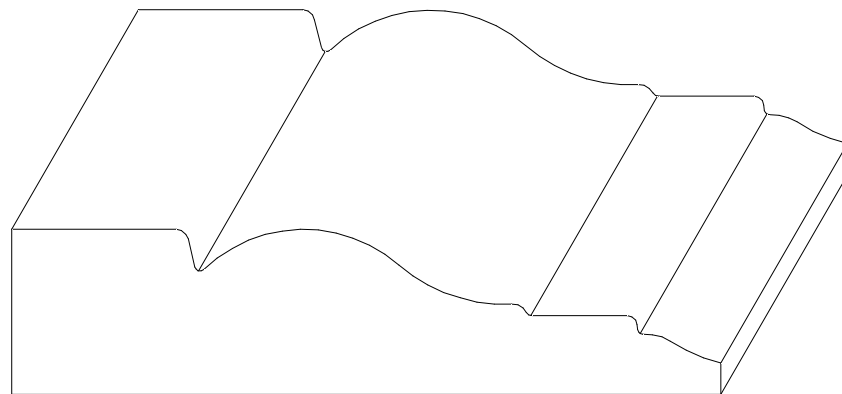

W-57
13/16" x 3 1/2"

CASING 3 1/2"

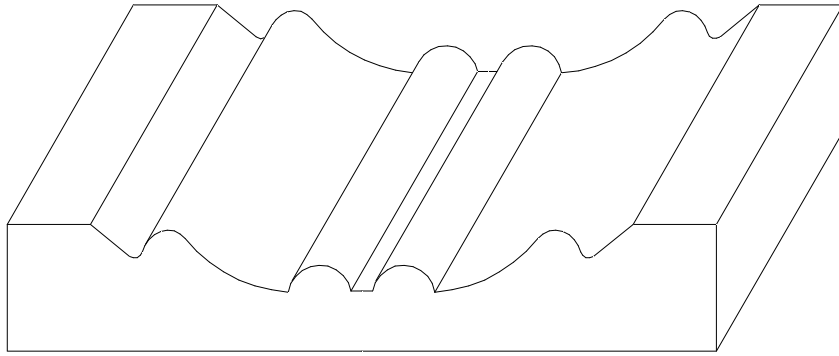

W-65
5/8" x 3 1/2"

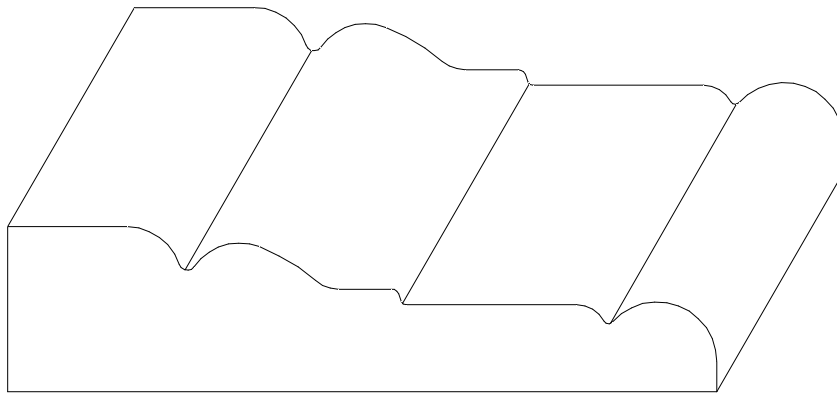

W-79
13/16" x 3 1/2"

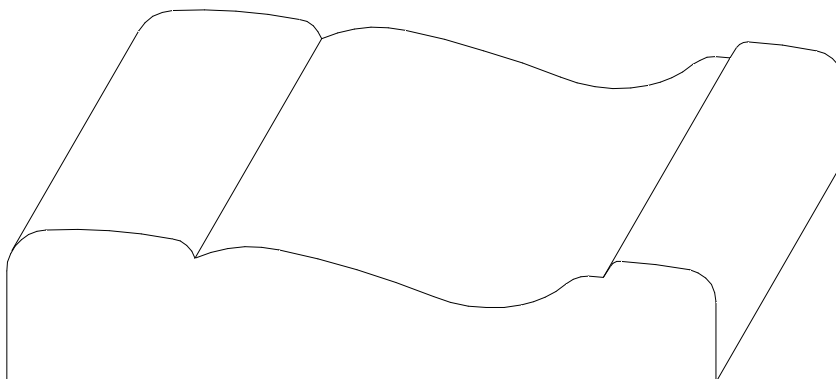

W-82
3/4" x 3 1/2"

CASING 3 1/2"

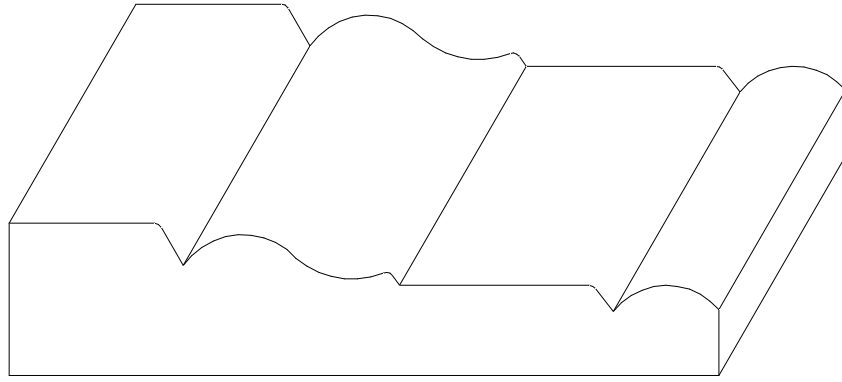

W-83
3/4" x 3 1/2"

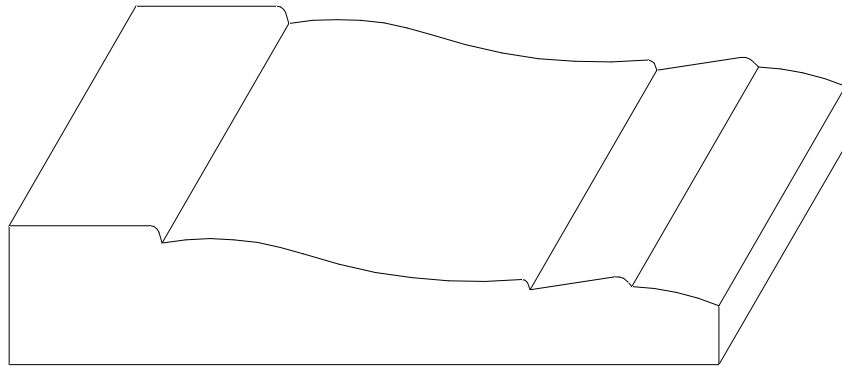

W-84
11/16" x 3 1/2"

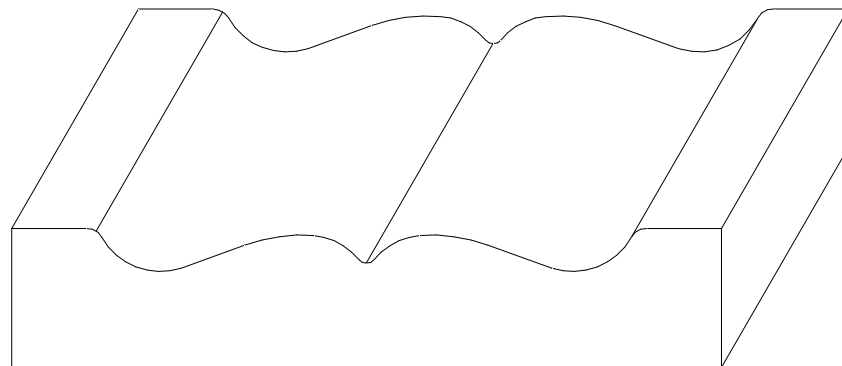

W-105
11/16" x 3 1/2"

CASING 3 1/2"

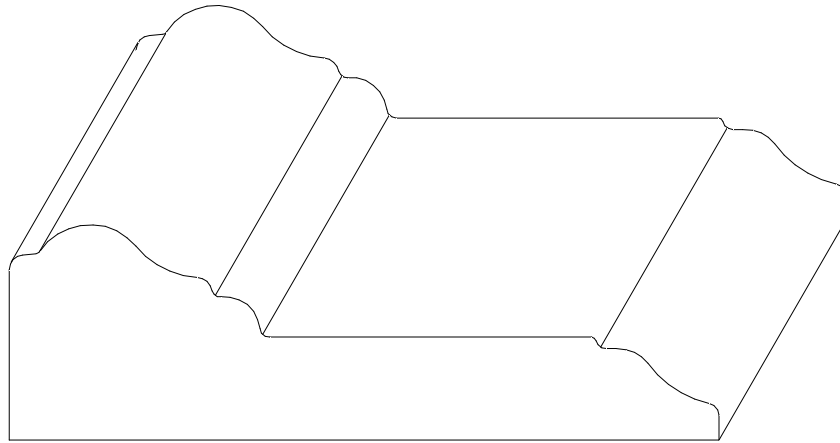

W-106
1 1/16" x 3 1/2"

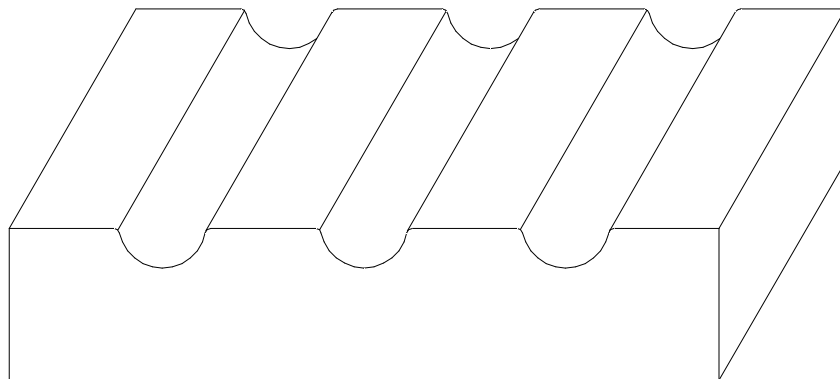

W-107
3/4" x 3 1/2"

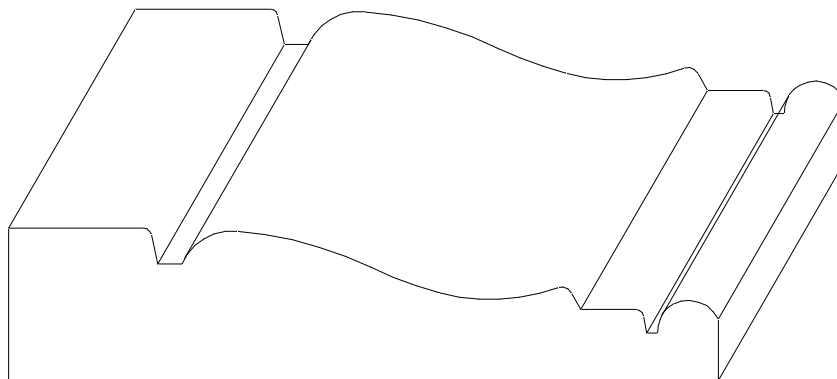

W-116
3/4" x 3 1/2"

CASING 3 1/2"

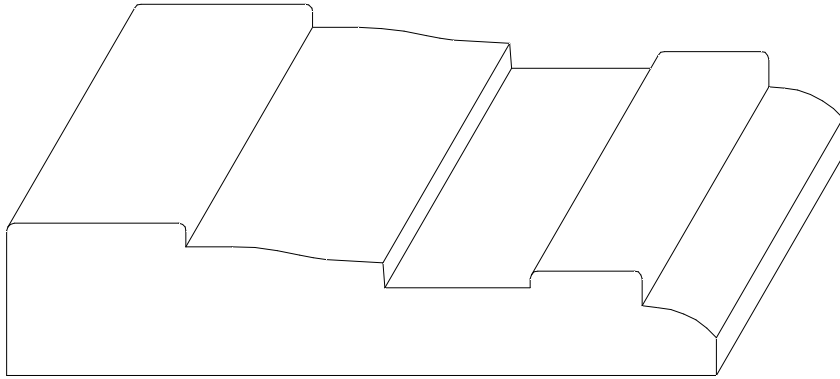

W-117
3/4" x 3 1/2"

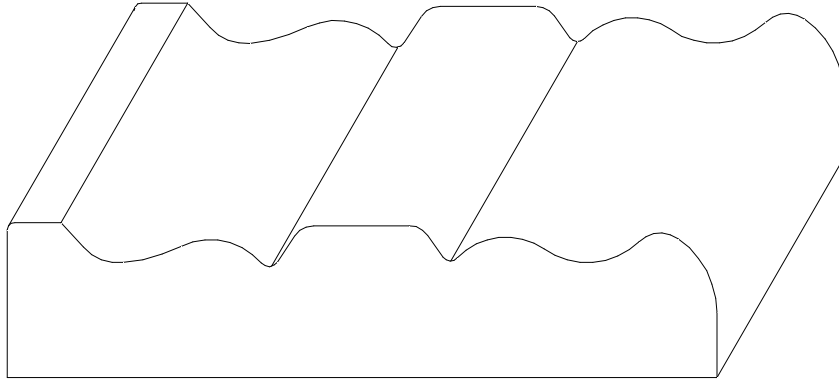

W-129
3/4" x 3 1/2"

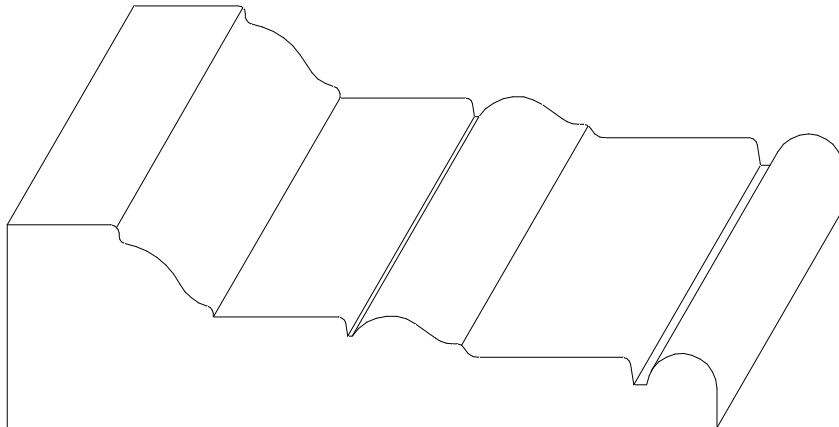

W-194
1" x 3 1/2"

CASING 3 1/2"

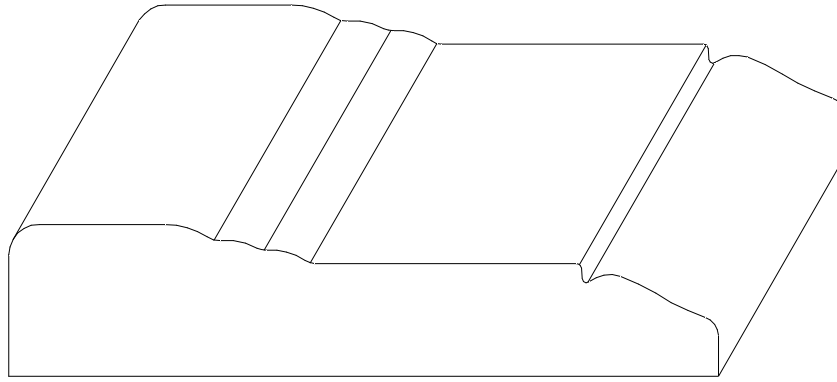

W-195
3/4" x 3 1/2"

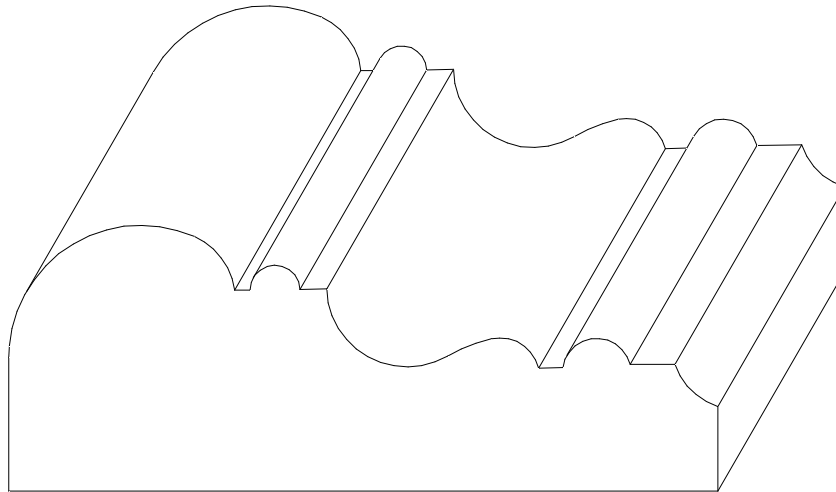

W-203
1 5/16" x 3 1/2"

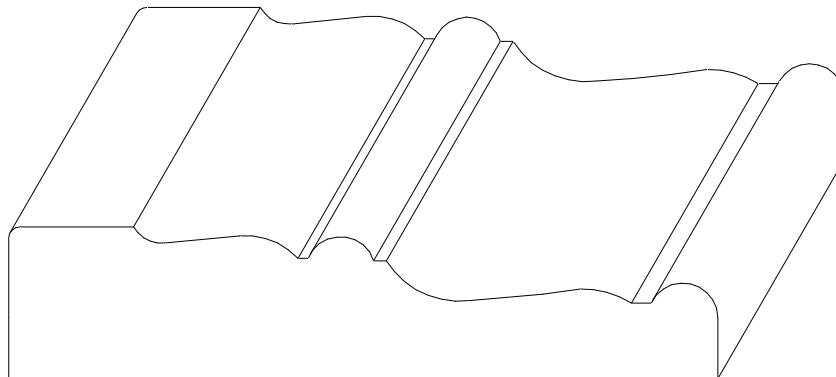

W-222
3/4" x 3 1/2"

CASING 3 1/2"

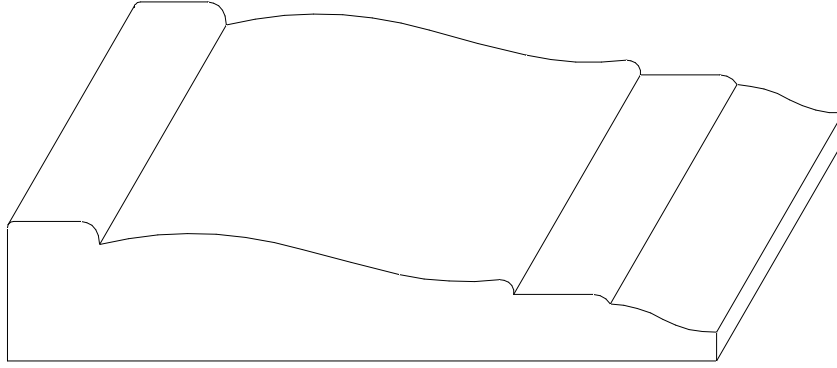

W-225
11/16" x 3 1/2"

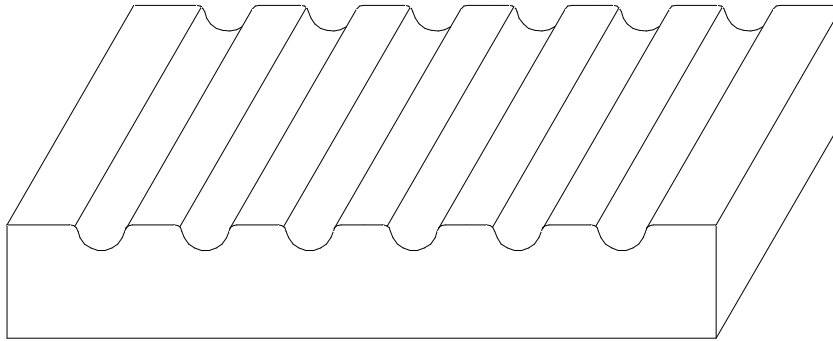

W-238
9/16" x 3 1/2"

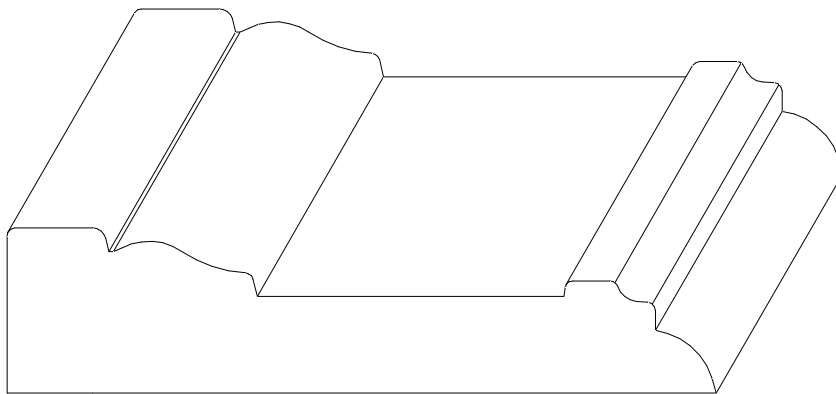

W-244
13/16" x 3 1/2"

CASING 3 1/2"

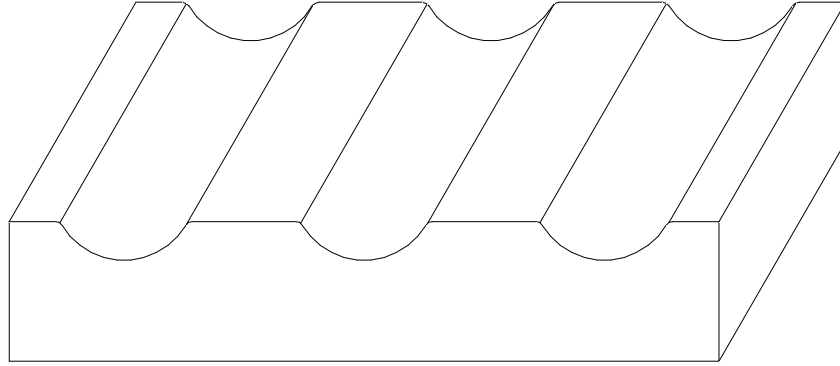

W-266
11/16" x 3 1/2"

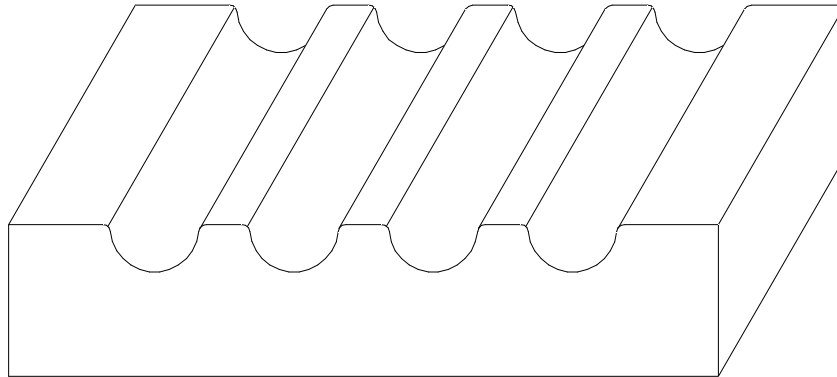

W-270
3/4" x 3 1/2"

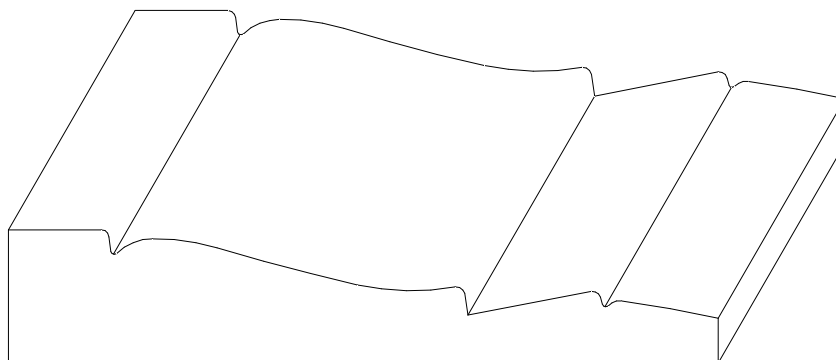

W-271
21/32" x 3 1/2"

CASING 3 1/2"

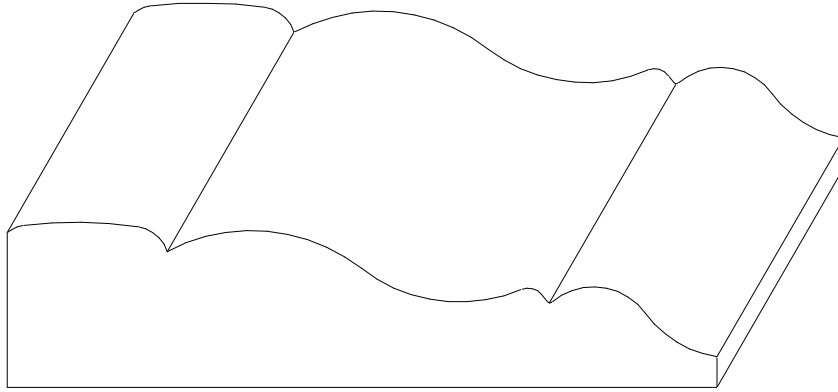

W-277
13/16" x 3 1/2"

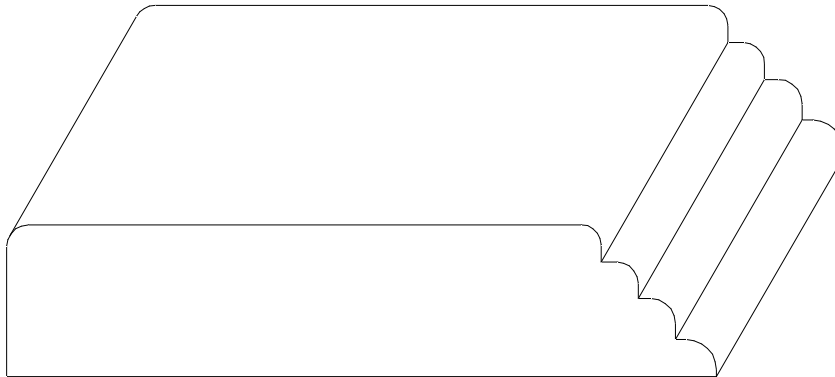

W-291
3/4" x 3 1/2"

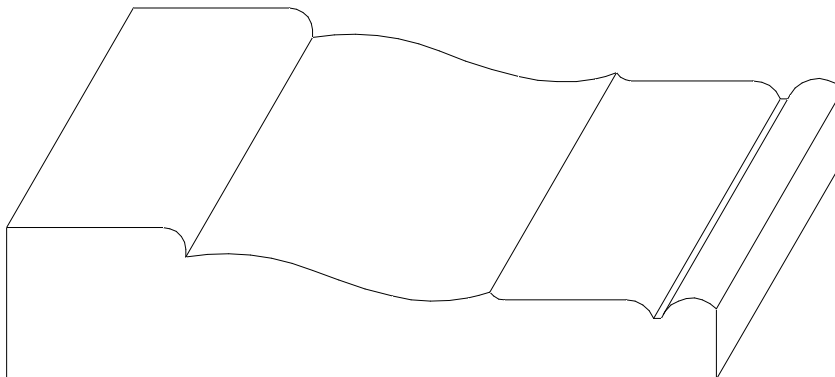

W-295
3/4" x 3 1/2"

CASING 3 1/2"

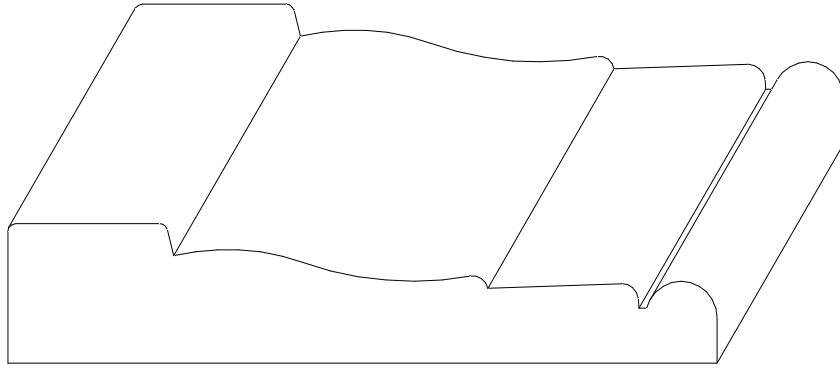

W-320
11/16" x 3 1/2"

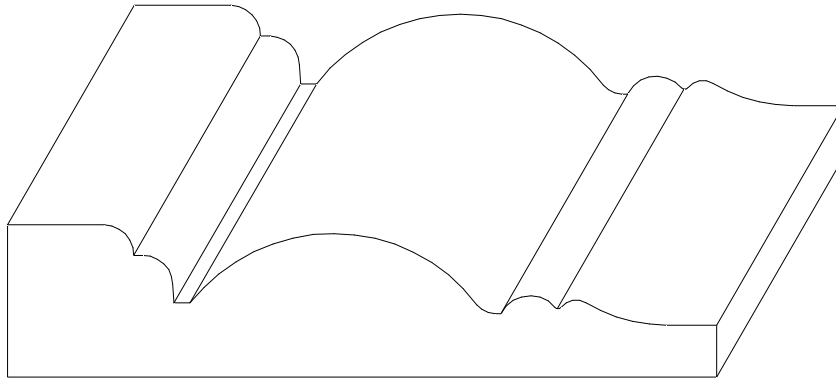

W-323
3/4" x 3 1/2"

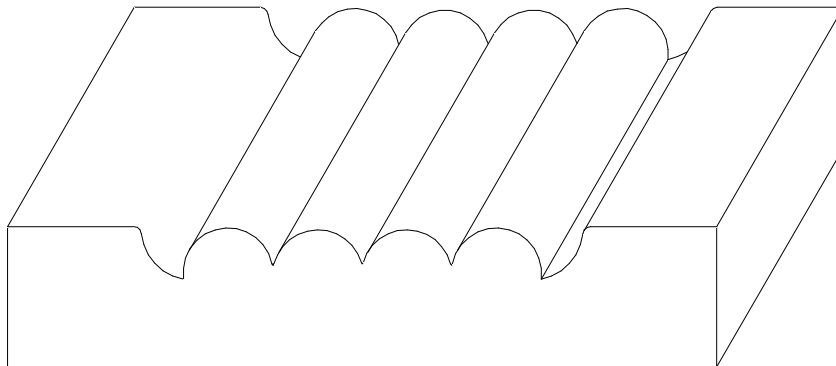

W-325
11/16" x 3 1/2"

CASING 3 1/2"

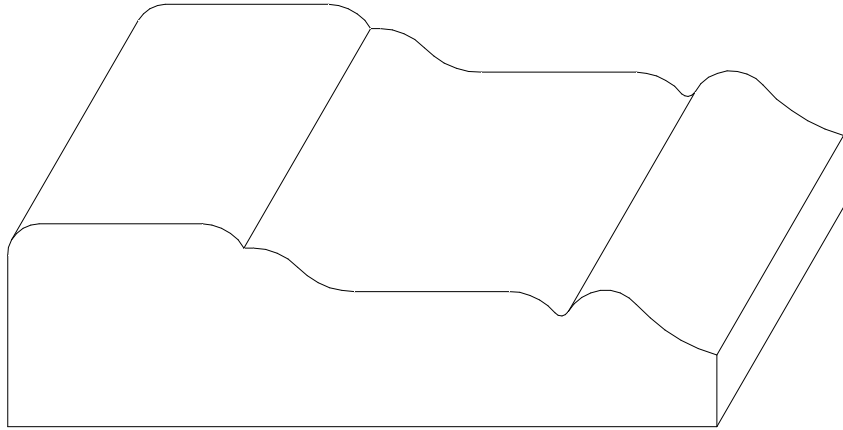

W-326
1" x 3 1/2"

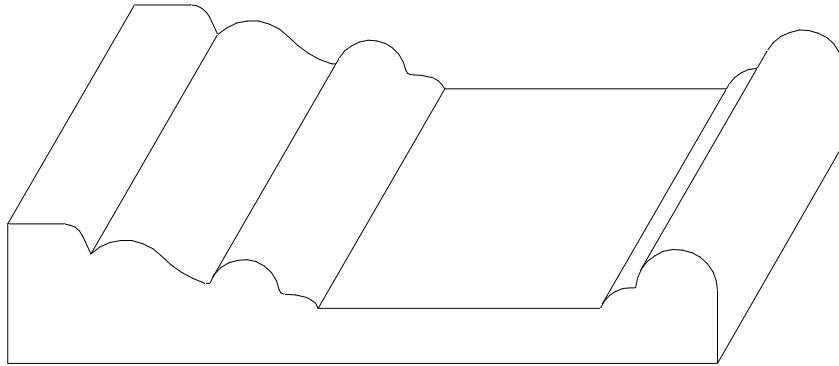

W-342
11/16" x 3 1/2"

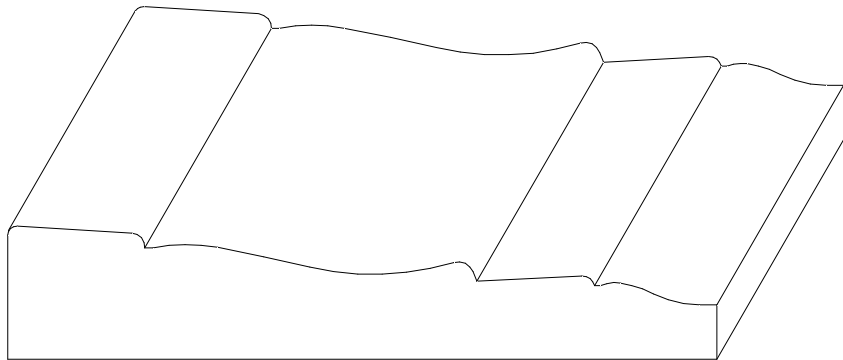

W-360
21/32" x 3 1/2"

CASING 3 1/2"

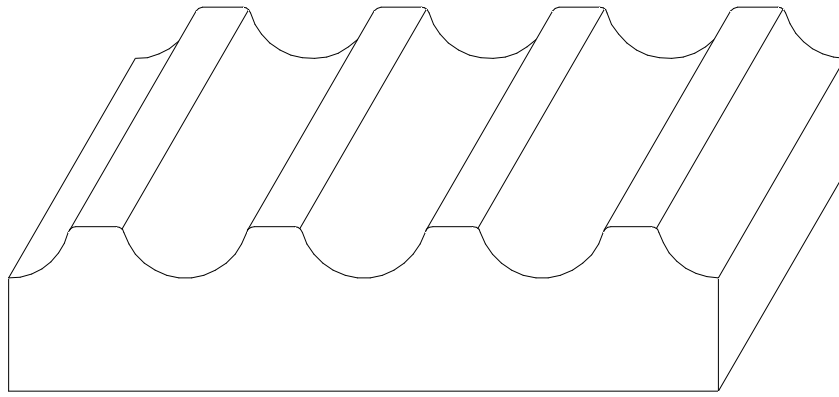

W-383
13/16" x 3 1/2"

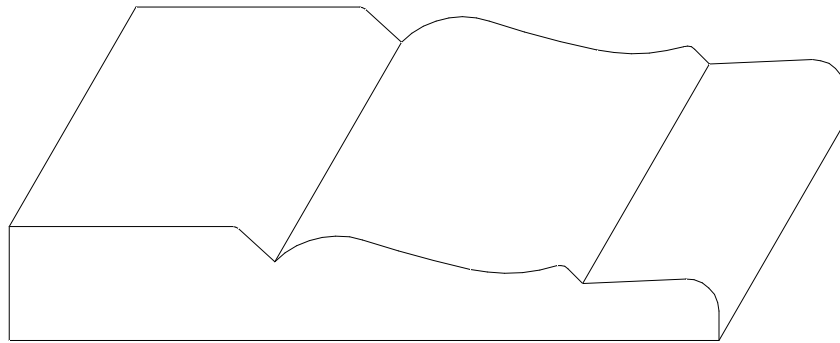

W-391
9/16" x 3 1/2"

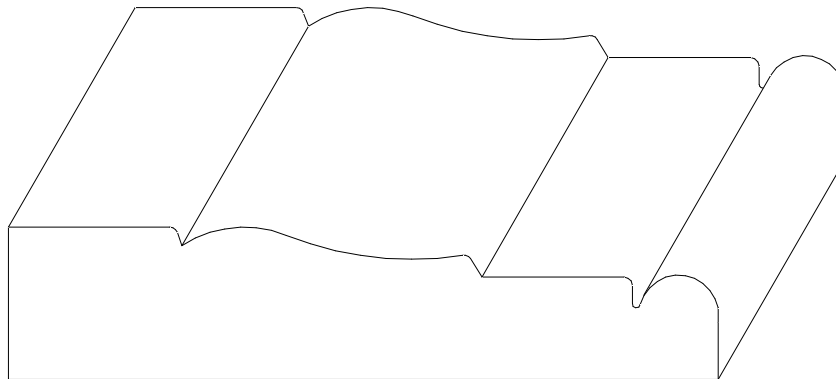

W-396
3/4" x 3 1/2"