

**CASING 5 1/4"**

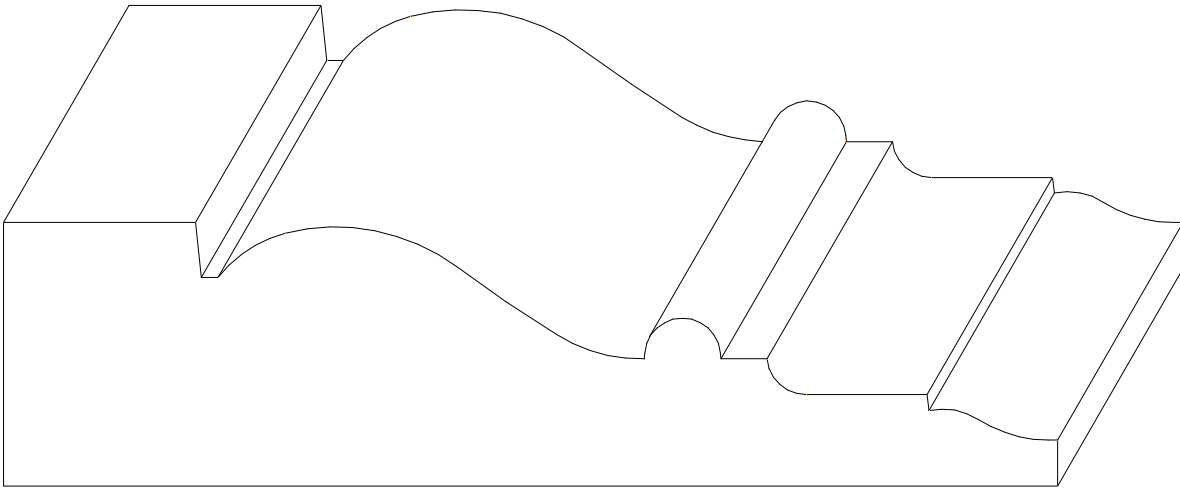

**W-46BC**  
**1 5/16" x 5 1/4"**

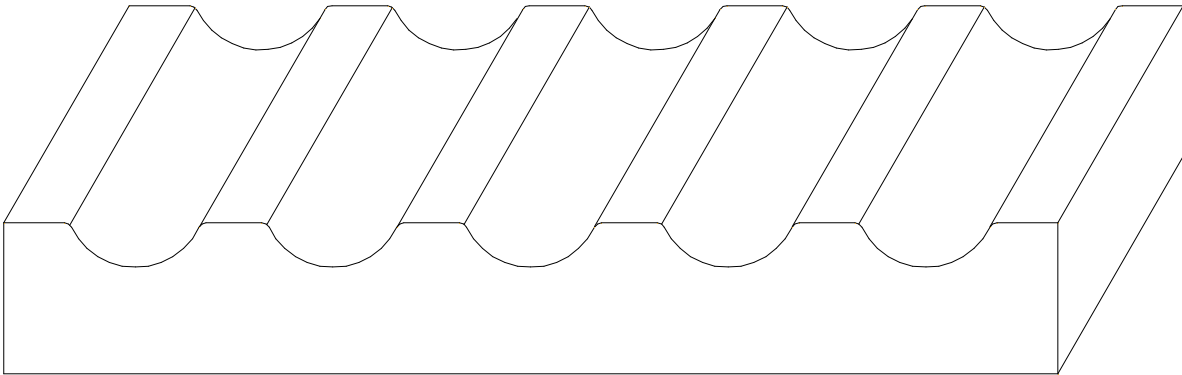

**W-63**  
**3/4" x 5 1/4"**

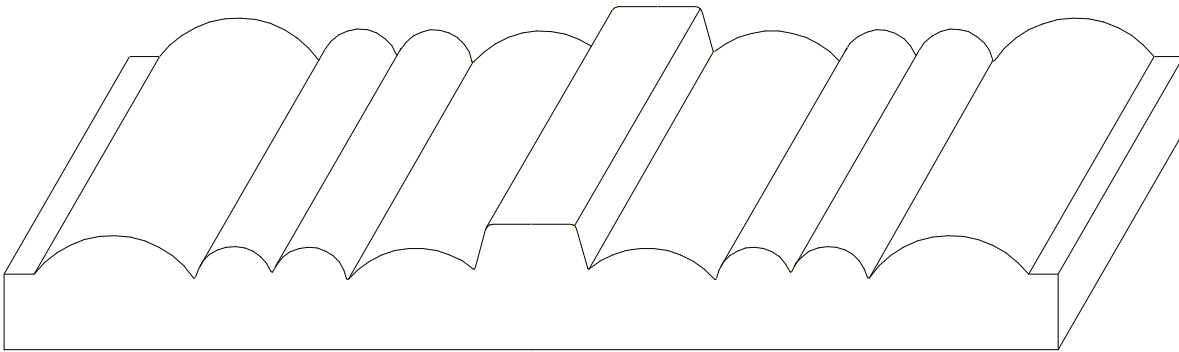

**W-93**  
**5/8" x 5 1/4"**

**CASING 5 1/4"**

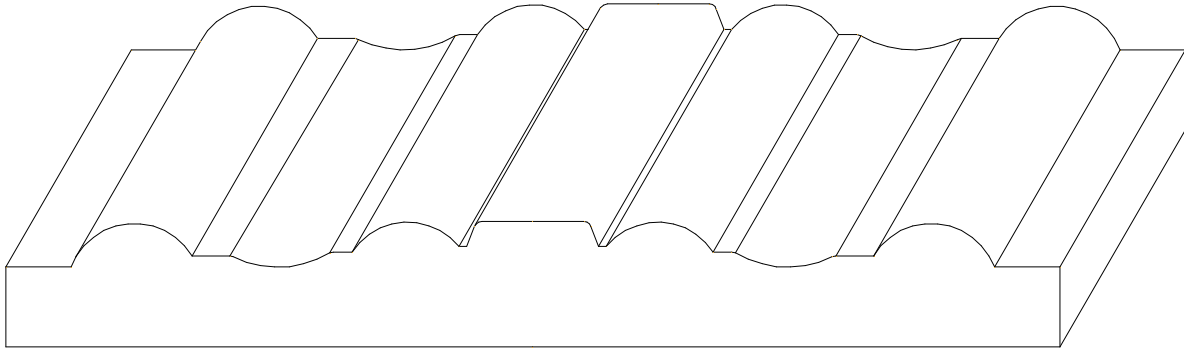

**W-99**  
**5/8" x 5 1/4"**

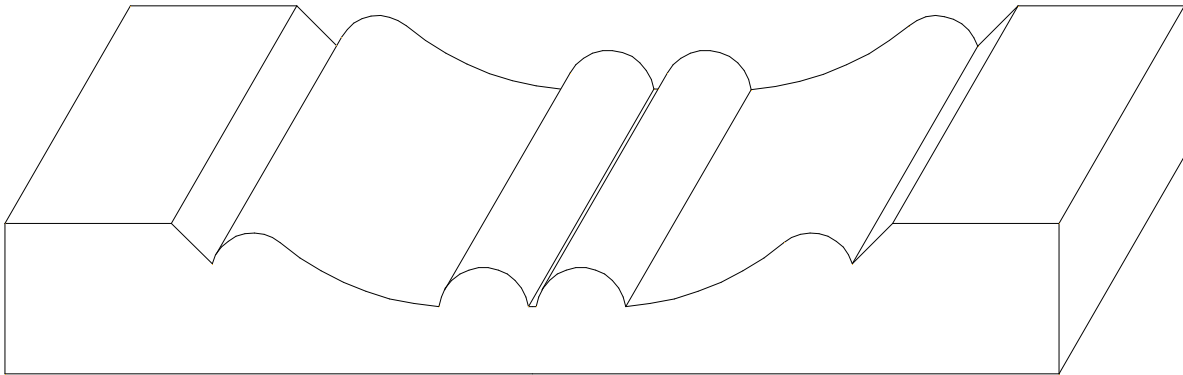

**W-100**  
**3/4" x 5 1/4"**

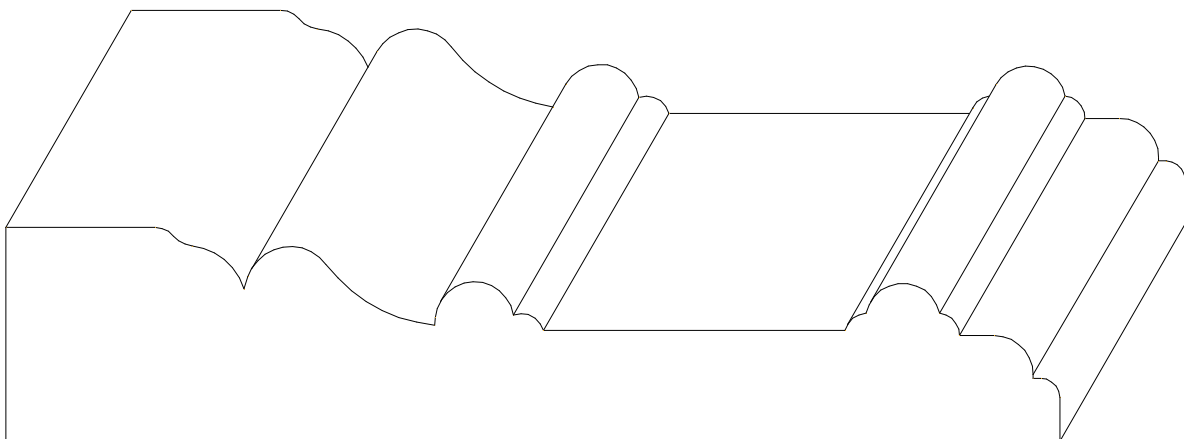

**W-113**  
**1 1/16" x 5 1/4"**

**CASING 5 1/4"**

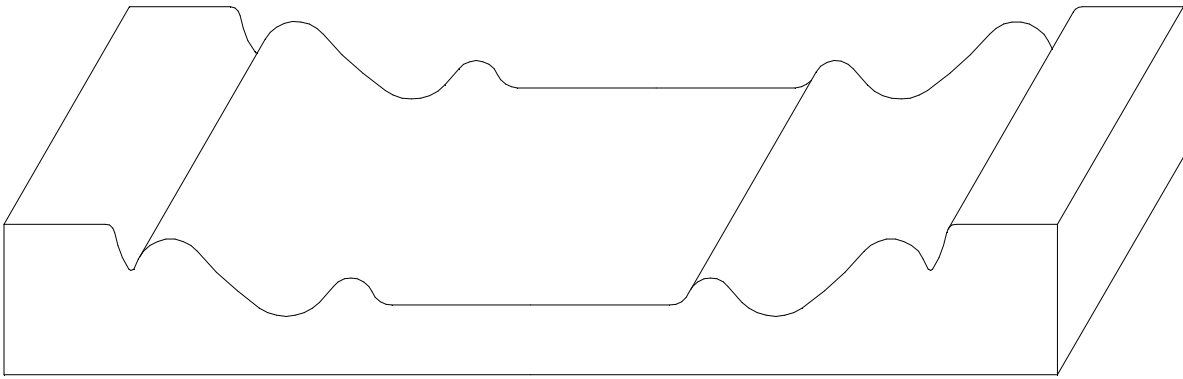

**W-114**  
**3/4" x 5 1/4"**

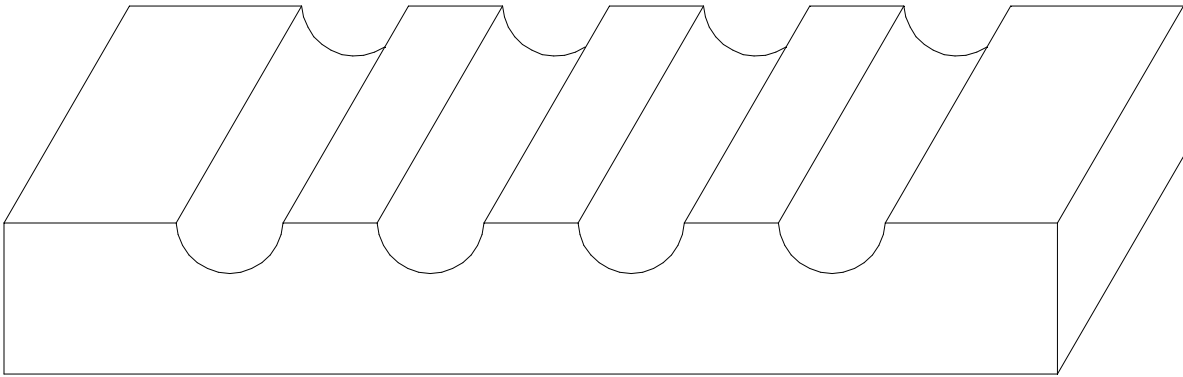

**W-164**  
**3/4" x 5 1/4"**

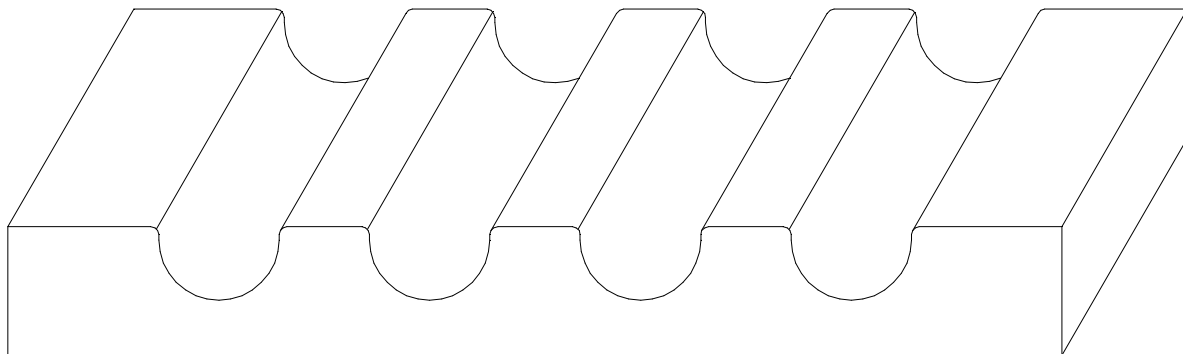

**W-482**  
**5/8" x 5 1/4"**

**CASING 5 1/4"**



**W-525**  
**3/4" x 5 1/4"**

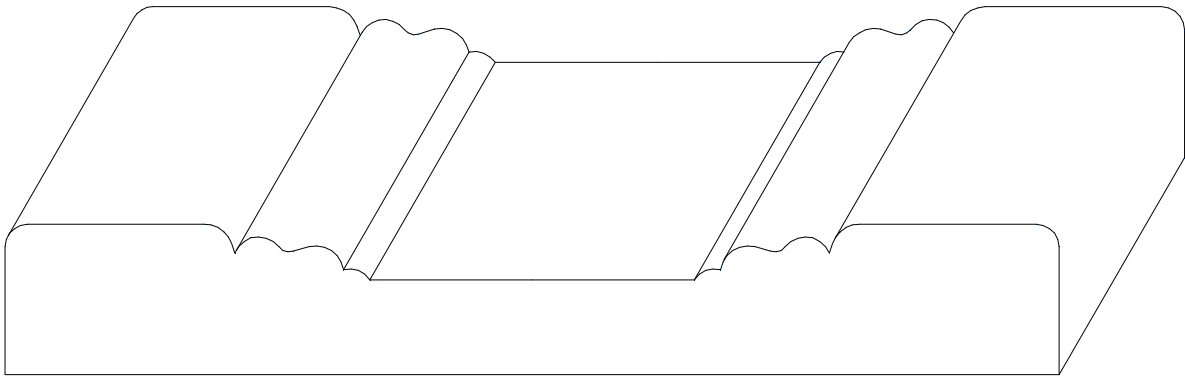

**W-600**  
**3/4" x 5 1/4"**

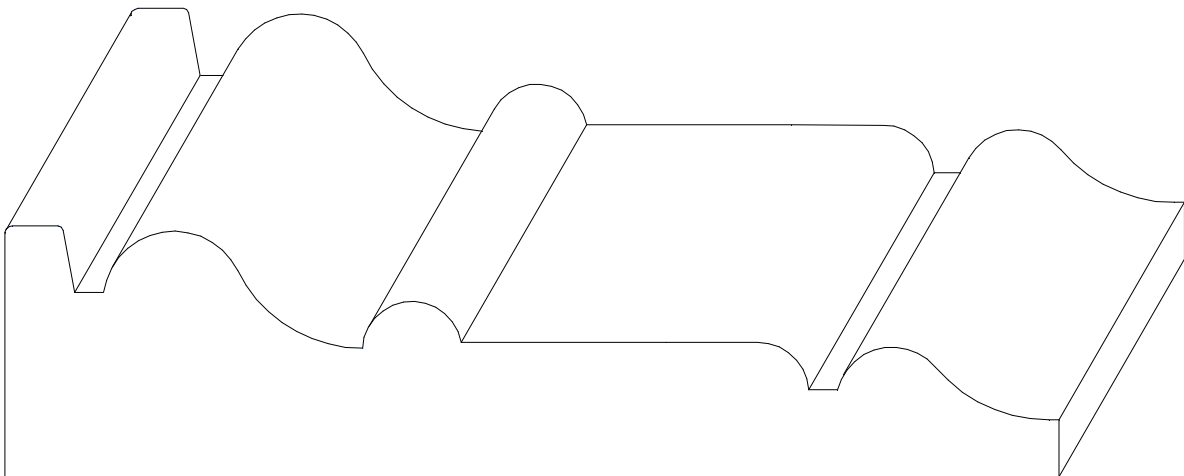

**W-607**  
**1 1/4" x 5 1/4"**

**CASING 5 1/4"**

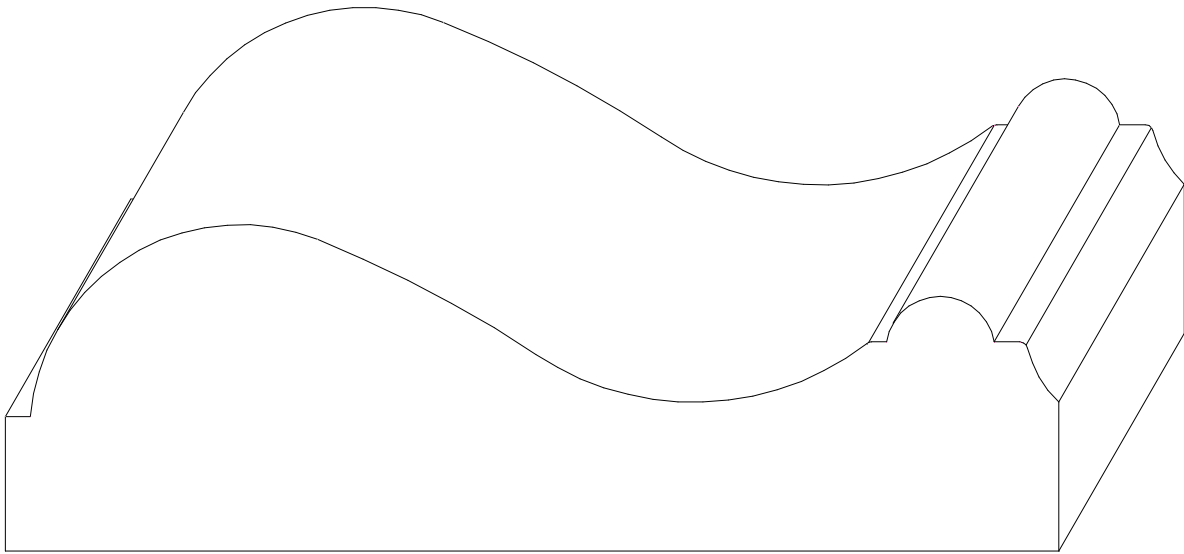

**W-657**  
**1 5/8" x 5 1/4"**



**W-738**  
**1 1/16" x 5 1/4"**

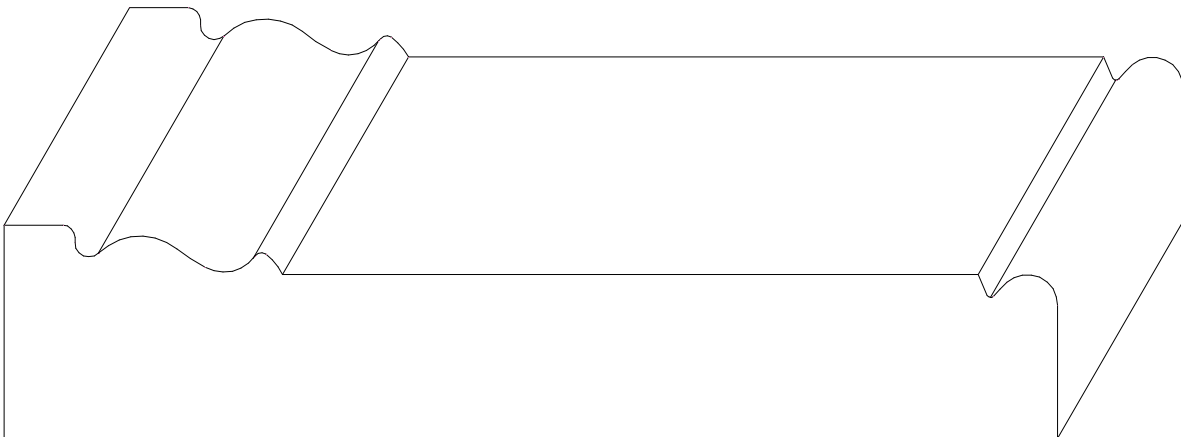

**W-1042**  
**1 1/16" x 5 1/4"**

**CASING 5 1/4"**

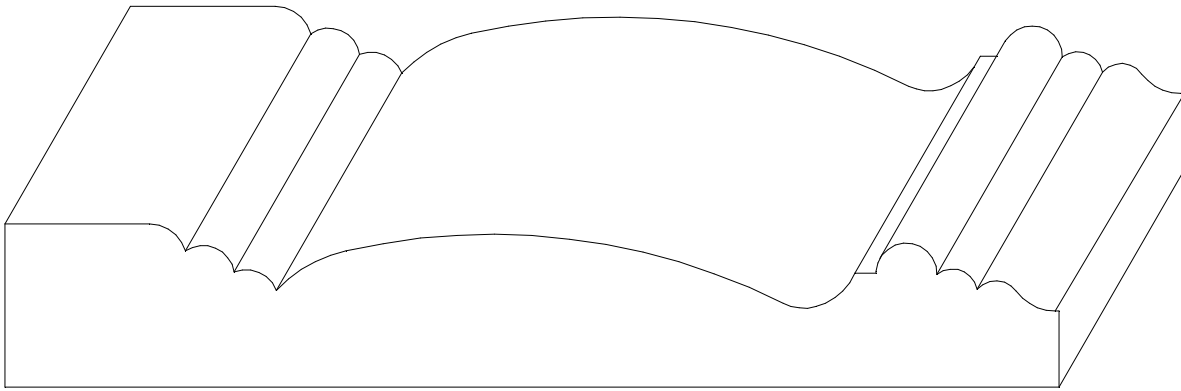

**W-1123**  
**13/16" x 5 1/4"**

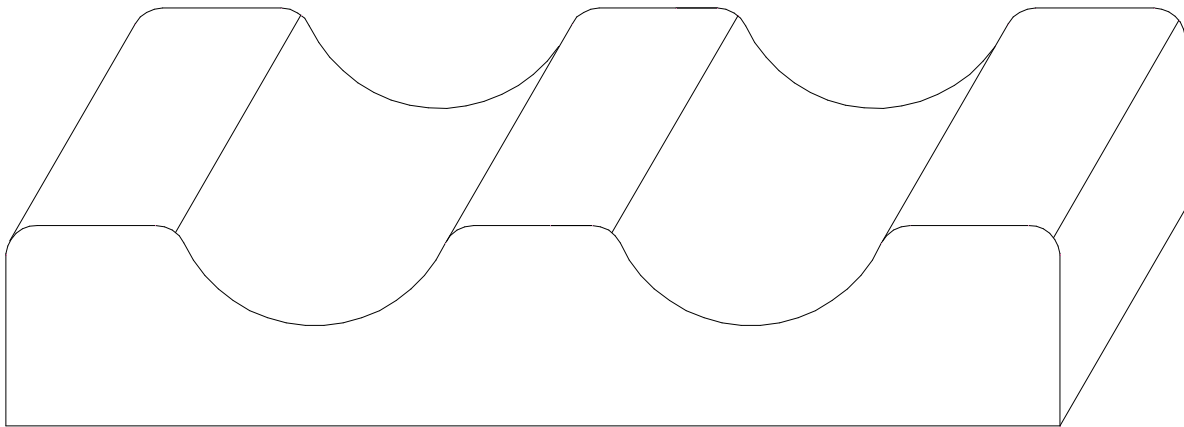

**W-1217**  
**1" x 5 1/4"**



**W-1225**  
**1" x 5 1/4"**

**CASING 5 1/4"**

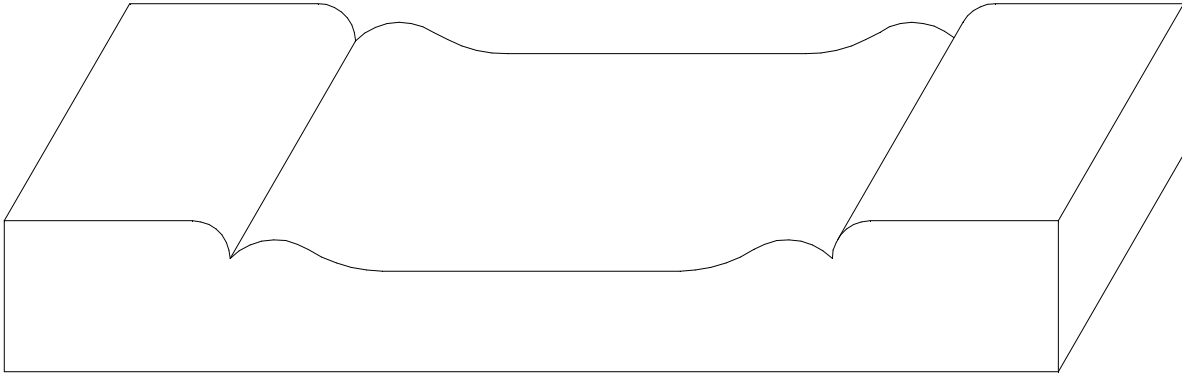

**W-1227**  
**3/4" x 5 1/4"**

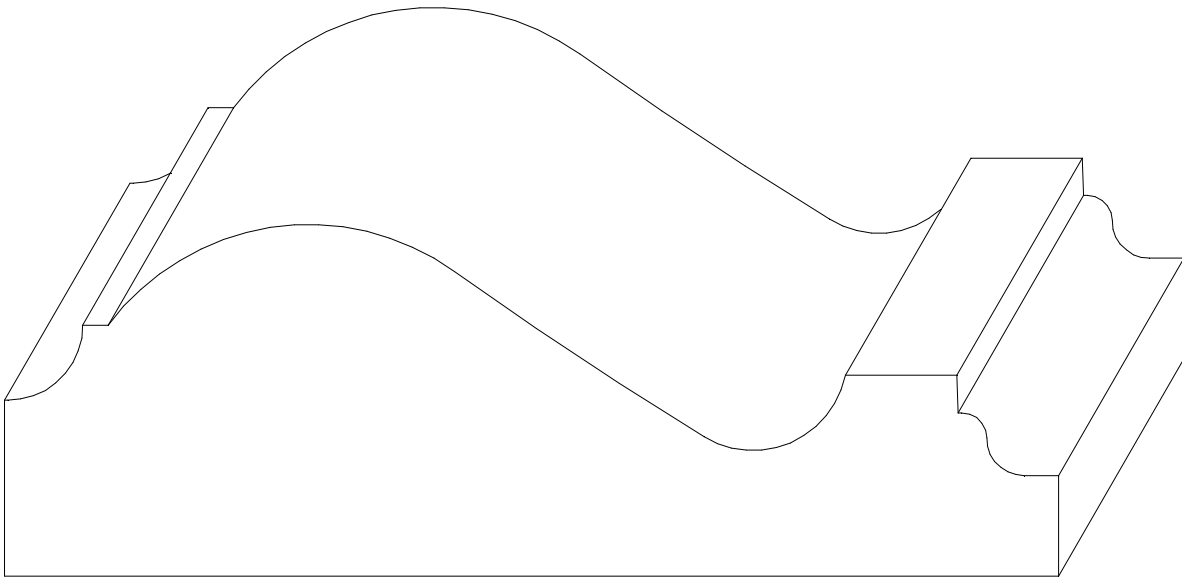

**W-1235**  
**1 3/4" x 5 1/4"**

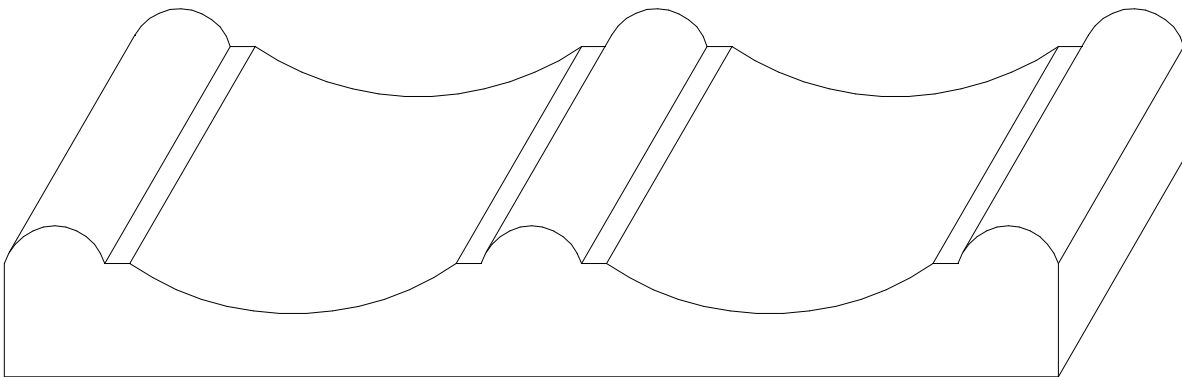

**W-1237**  
**3/4" x 5 1/4"**

**CASING 5 1/4"**

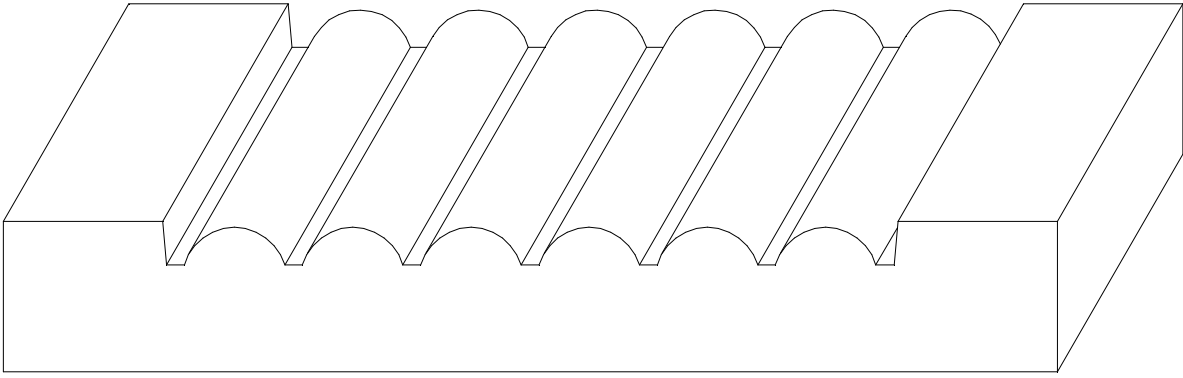

**W-1248**  
**3/4" x 5 1/4"**

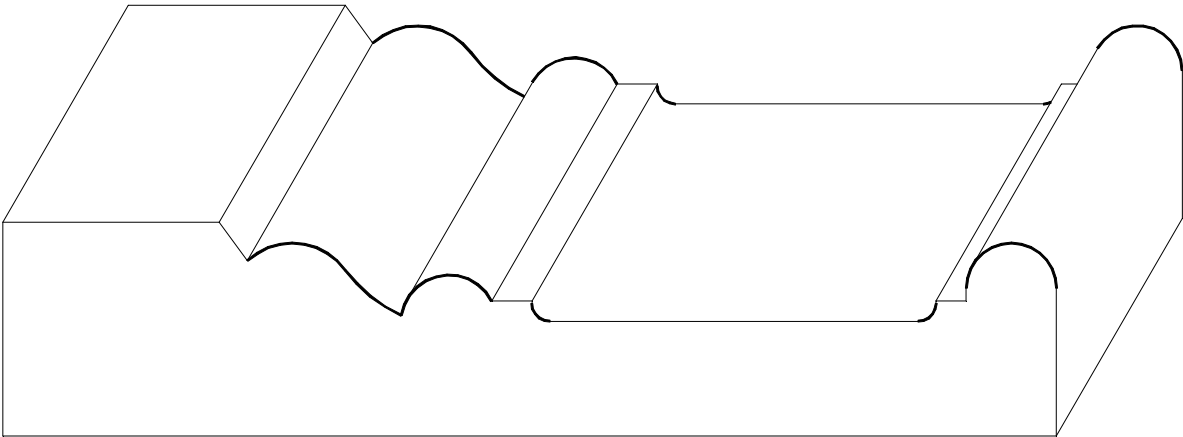

**W-1416**  
**1 1/16" x 5 1/4"**

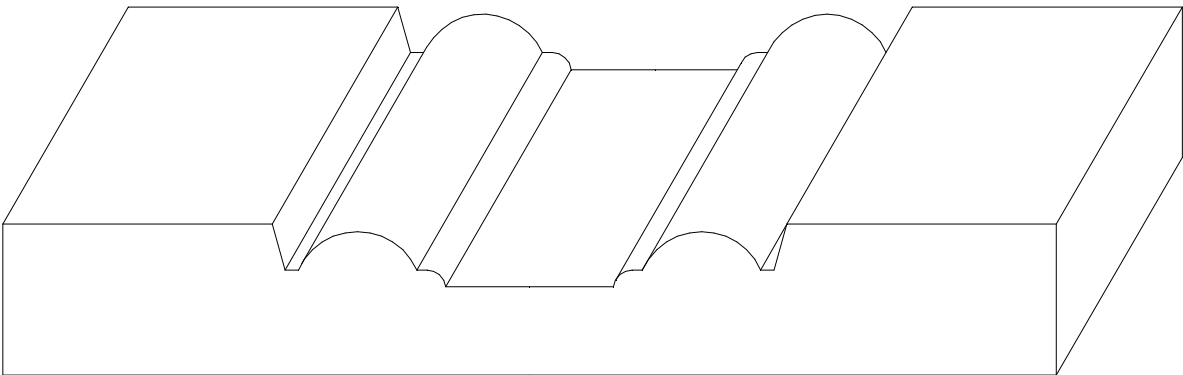

**W-1455**  
**3/4" x 5 1/4"**



**CASING 5 1/4"**

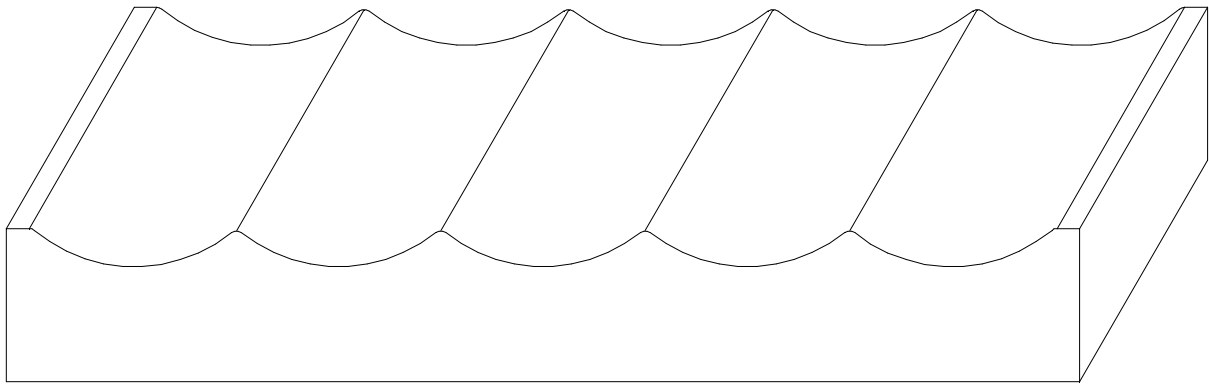

**W-1641**  
**3/4" x 5 1/4"**

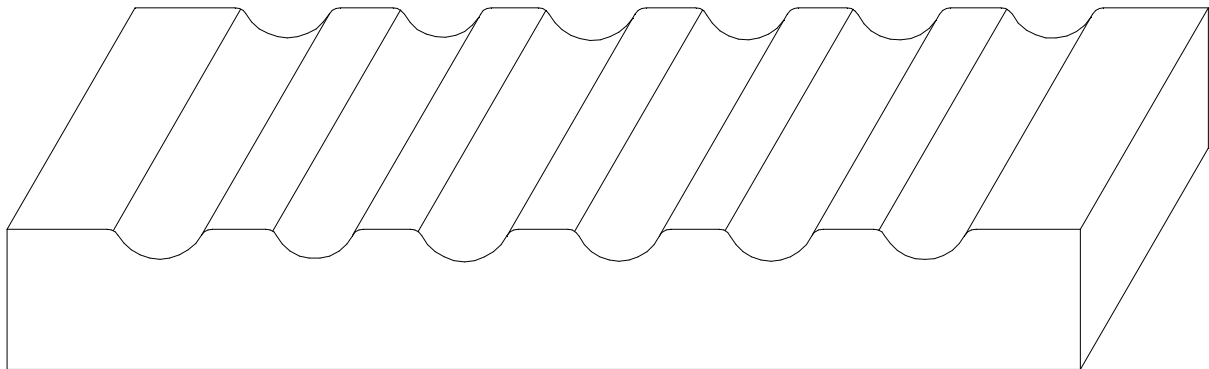

**W-1644**  
**11/16" x 5 1/4"**

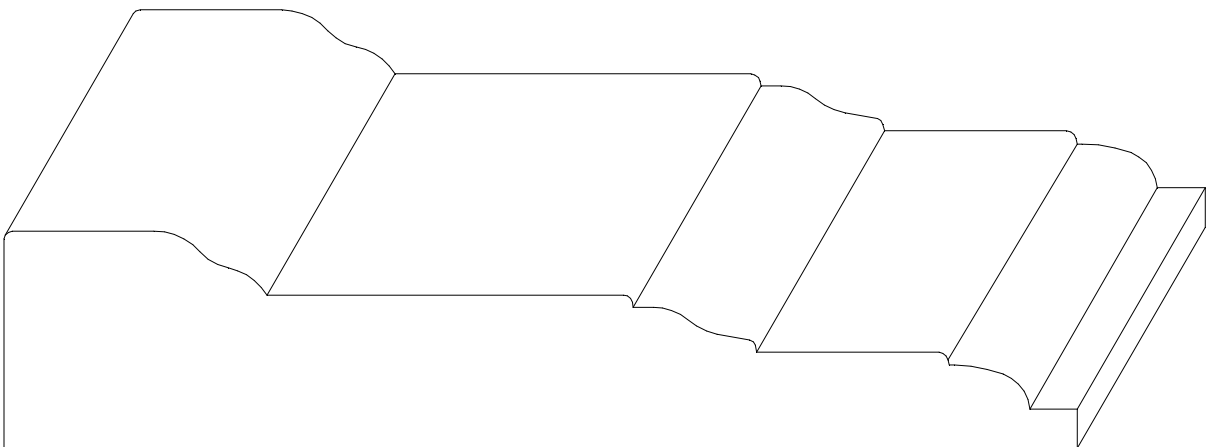

**W-1987**  
**1 1/16" x 5 1/4"**

**CASING 5 1/4"**



**W-1998**  
**1 1/16" x 5**  
**1/4"**

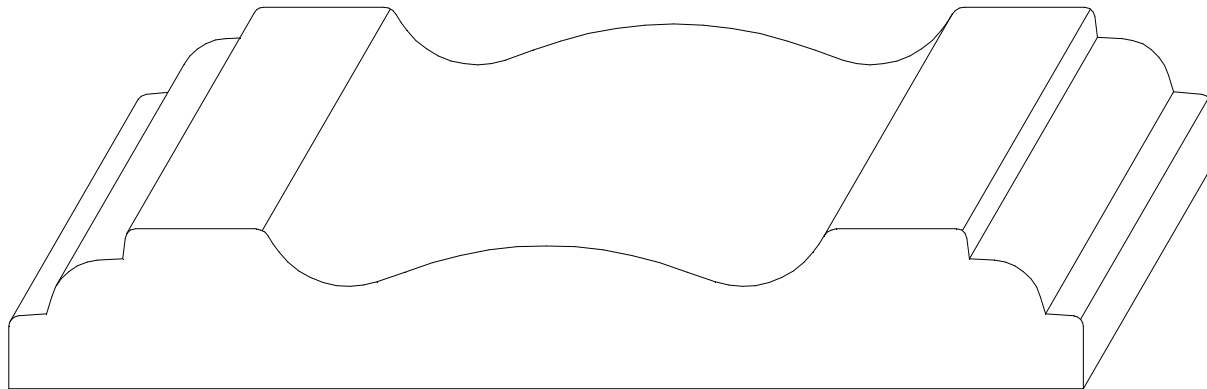

**W-2009**  
**3/4" x 5 1/4"**

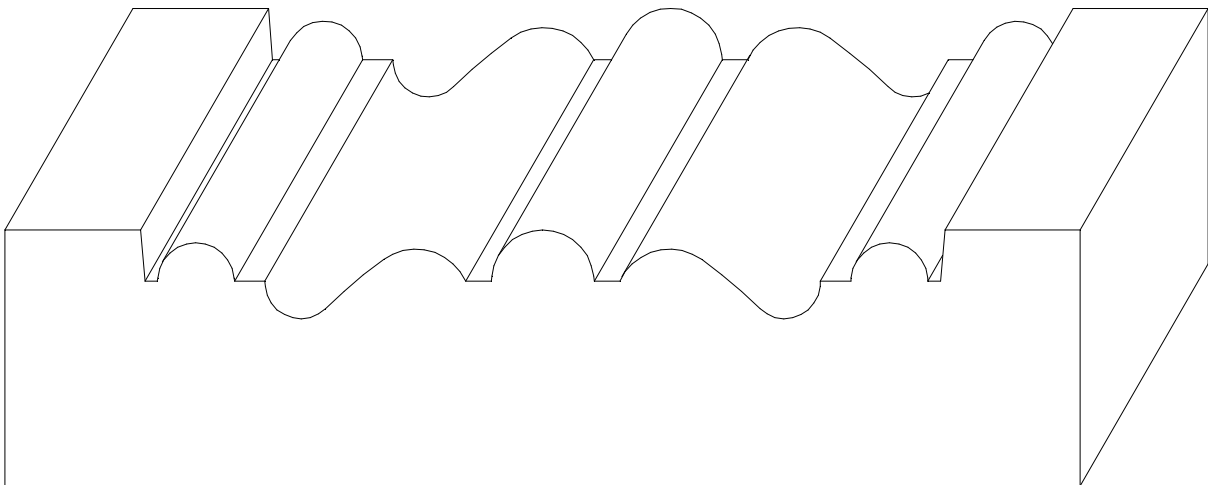

**W-2143**  
**1 1/4" x 5 1/4"**

**CASING 5 1/4"**



**W-2154**  
**3/4" x 5**  
**1/4"**

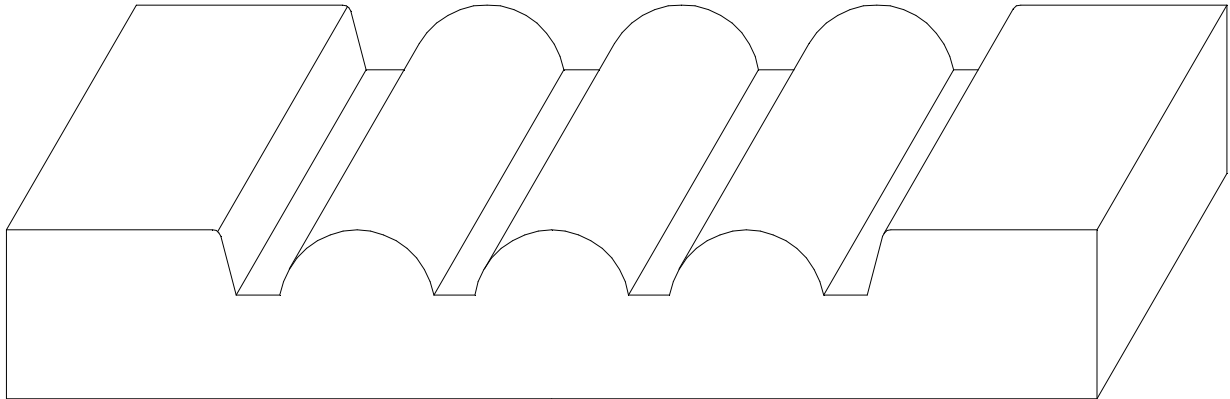

**W-2175**  
**13/16" x 5 1/4"**

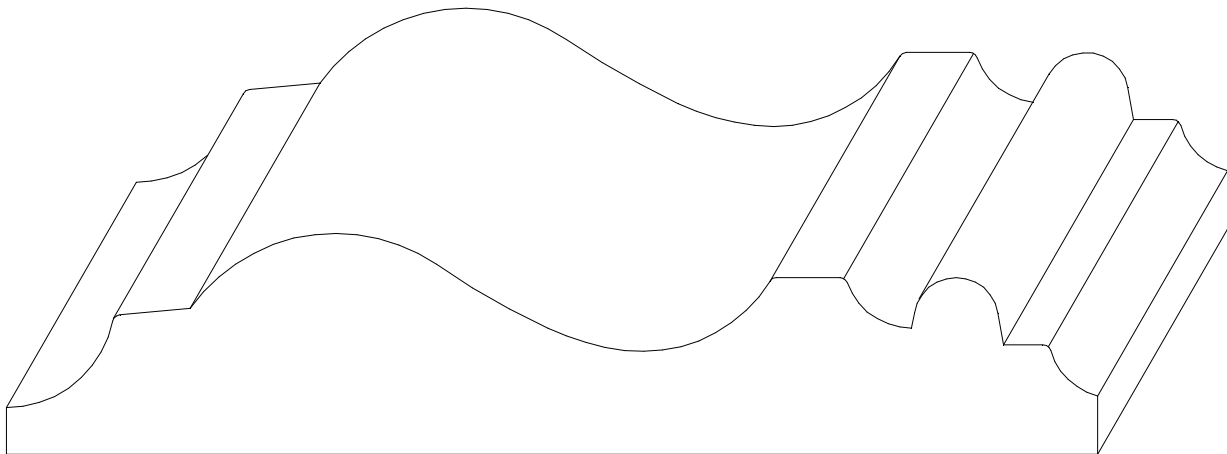

**W-2237**  
**1-1/16" x**  
**5-1/4"**  
**PAGE 11**

**CASING 5-1/4"**

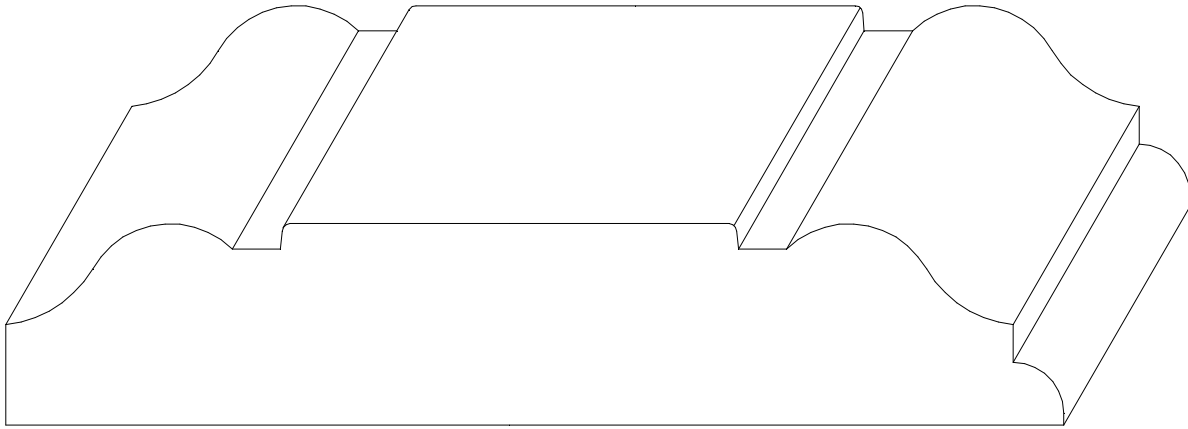

**W-2267**  
**1" x 5-1/4"**

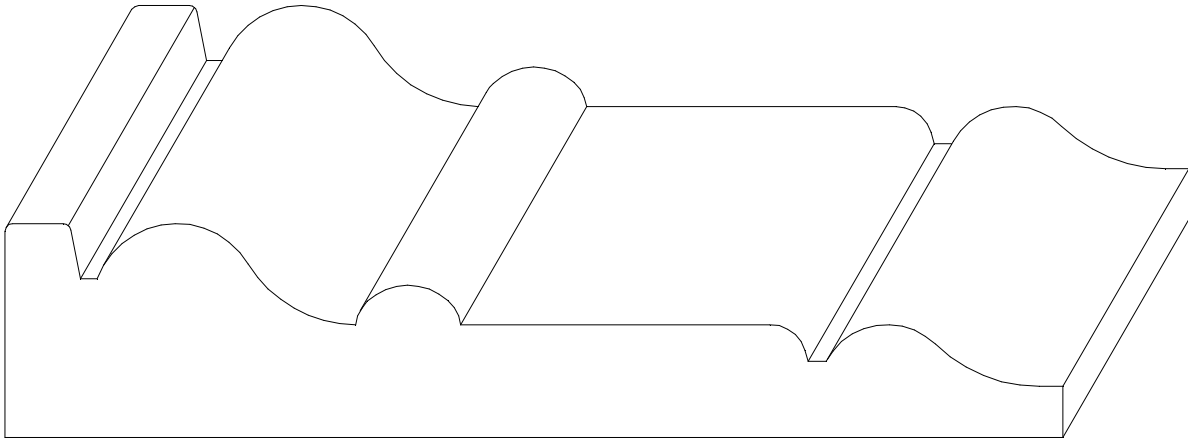

**W-2440**  
**1-1/16" x 5-1/4"**

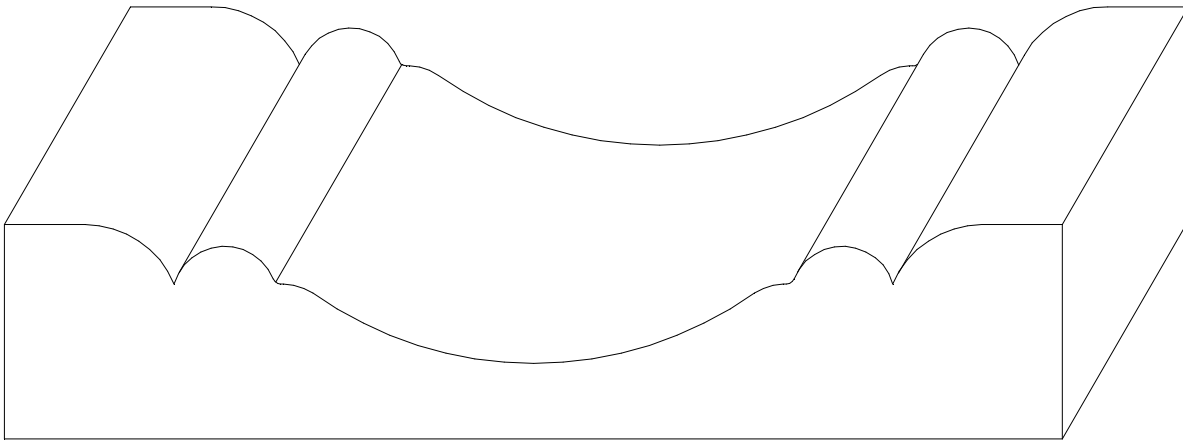

**W-2483**  
**1-1/16" x 5-1/4"**